



**GRAND**  
DESIGN • BUILD

268 River Road East  
Wasaga Beach

NELLY@GrandDesignBuild.com

# DESIGN ETHOS

---

PLACE . SPACE . VOID

Place is the product of lived space and lived time, a reflection of our states of mind and heart. A home is the outward expression of our souls. It represents the way we want to live, the values and ideals that define us and the intricate ways through which our sense of aesthetic is bound to the world around us.

NELLY MOLAEI



# ONE PANEL SHAKER BLUE 800



WHITE MATT  
BACKSPLASH



# KITCHEN DESIGN







Light green upper and lower cabinets with a classic panel design. A tall cabinet is on the left, and a refrigerator with a water dispenser is integrated into the lower cabinets.

Red brick backsplash with a black metal shelving unit holding various kitchen items like wine glasses, mugs, and bowls. A black range hood is mounted above the stove area.

Central island with a dark countertop and light green base. Two black bar stools with silver bases are positioned under the island. A wooden bowl sits on the countertop.

A tall, white, rectangular pillar located on the right side of the kitchen, separating the island area from the rest of the room.

Light green lower cabinets with drawers on the right side. A black metal shelving unit is mounted on the brick wall above the counter, holding various kitchen items.







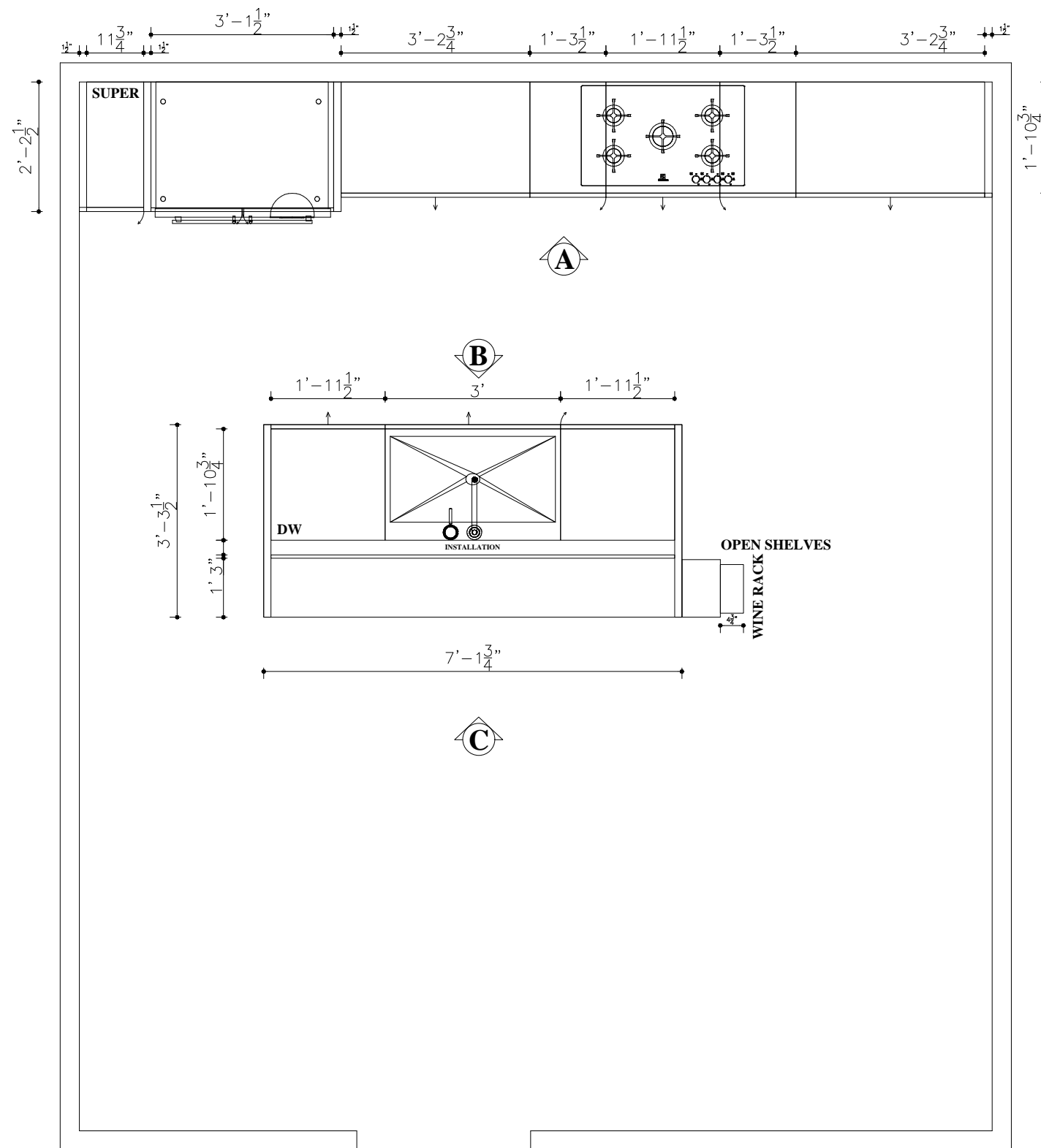

COUNTERTOPS: G034 LACUNA- SIO4

KITCHEN CABINET:  
MDF PAINT BLUE 800  
ONE SHAKER DESIGN

HARDWARES:MODERN SQUARE

SINK:208044 UNDER MOUNT

COOKTOP:  
30"W

SINGLE WALL OVEN:

DISHWASHER:

SIDE BY SIDE REFRIGERATOR:  
36"W

**PLAN VIEW**



**PROJECT TITLE:  
268 RIVER ROAD**

**TITLE:  
KITCHEN DESIGN**

All dimensions are subject to verification and adjustment on jobsite to fit job condition.

**PRODUCED BY:  
N.M**

**SIGN&DATE:**



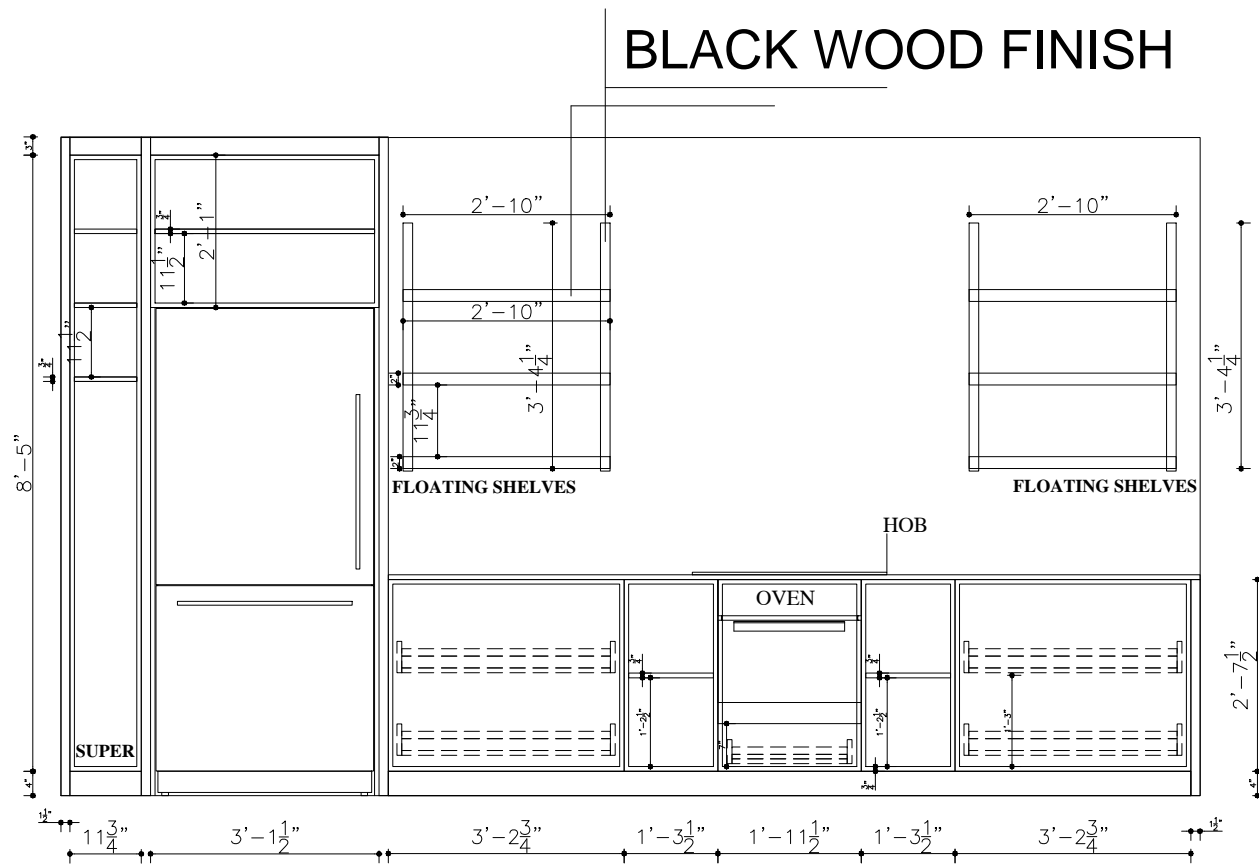

COOKTOP:  
30"W

SINGLE WALL OVEN:

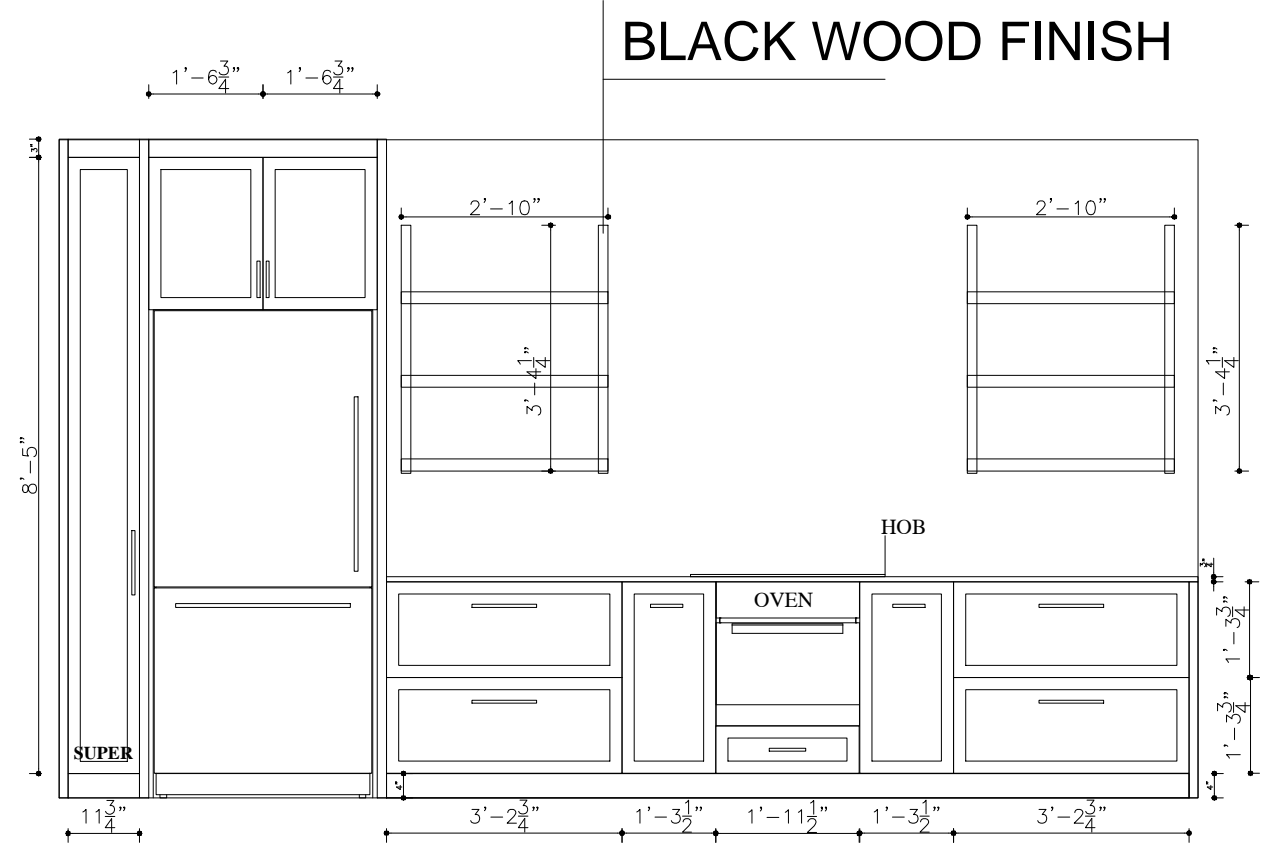

COUNTERTOPS: G034 LACUNA- SIO4

KITCHEN CABINET:  
MDF PAINT BLUE 800  
ONE SHAKER DESIGN

VIEW A



PROJECT TITLE:  
268RIVER ROAD

TITLE:  
KITCHEN DESIGN

All dimensions are subject to verification and adjustment on jobsite to fit job condition.

PRODUCED BY:  
N.M

SIGN&DATE:

**BLACK WOOD FINISH**

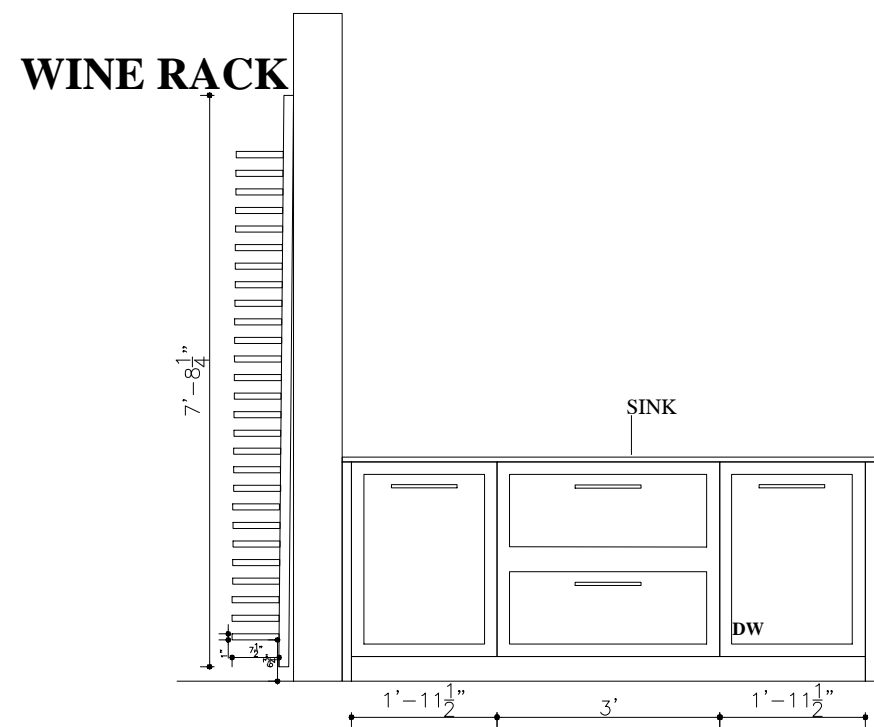
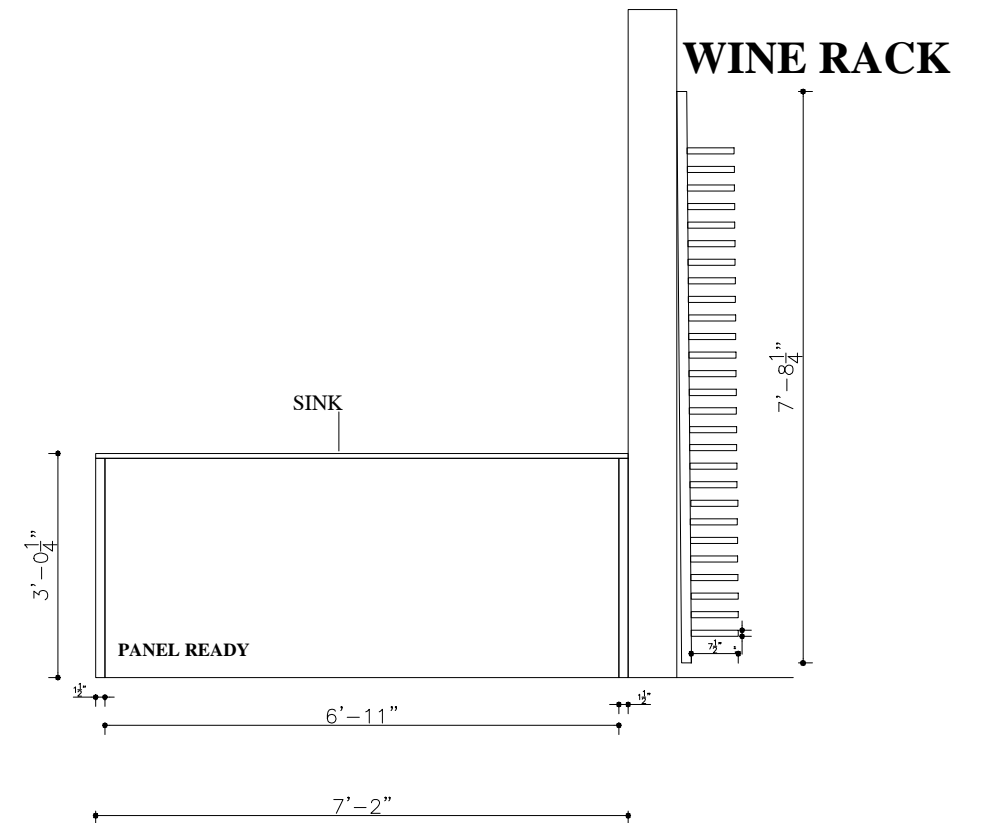
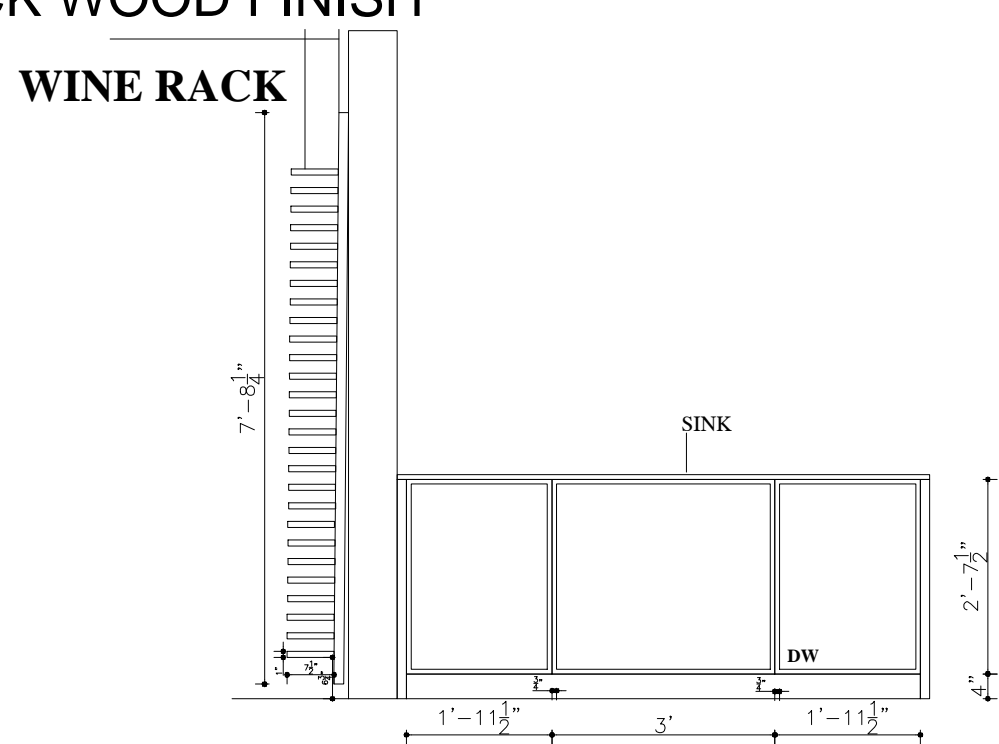

COUNTERTOPS: G034 LACUNA- SIO4

KITCHEN CABINET:  
MDF PAINT BLUE 800  
ONE SHAKER DESIGN

SINK:208044 UNDER MOUNT

**VIEW B . C**



**PROJECT TITLE:**  
268 RIVER ROAD

**TITLE:**  
KITCHEN DESIGN

All dimensions are subject to verification and adjustment on jobsite to fit job condition.

**PRODUCED BY:**  
N.M

**SIGN&DATE:**



MASTER ENSUITE

# MAIN FLOOR BATHROOM





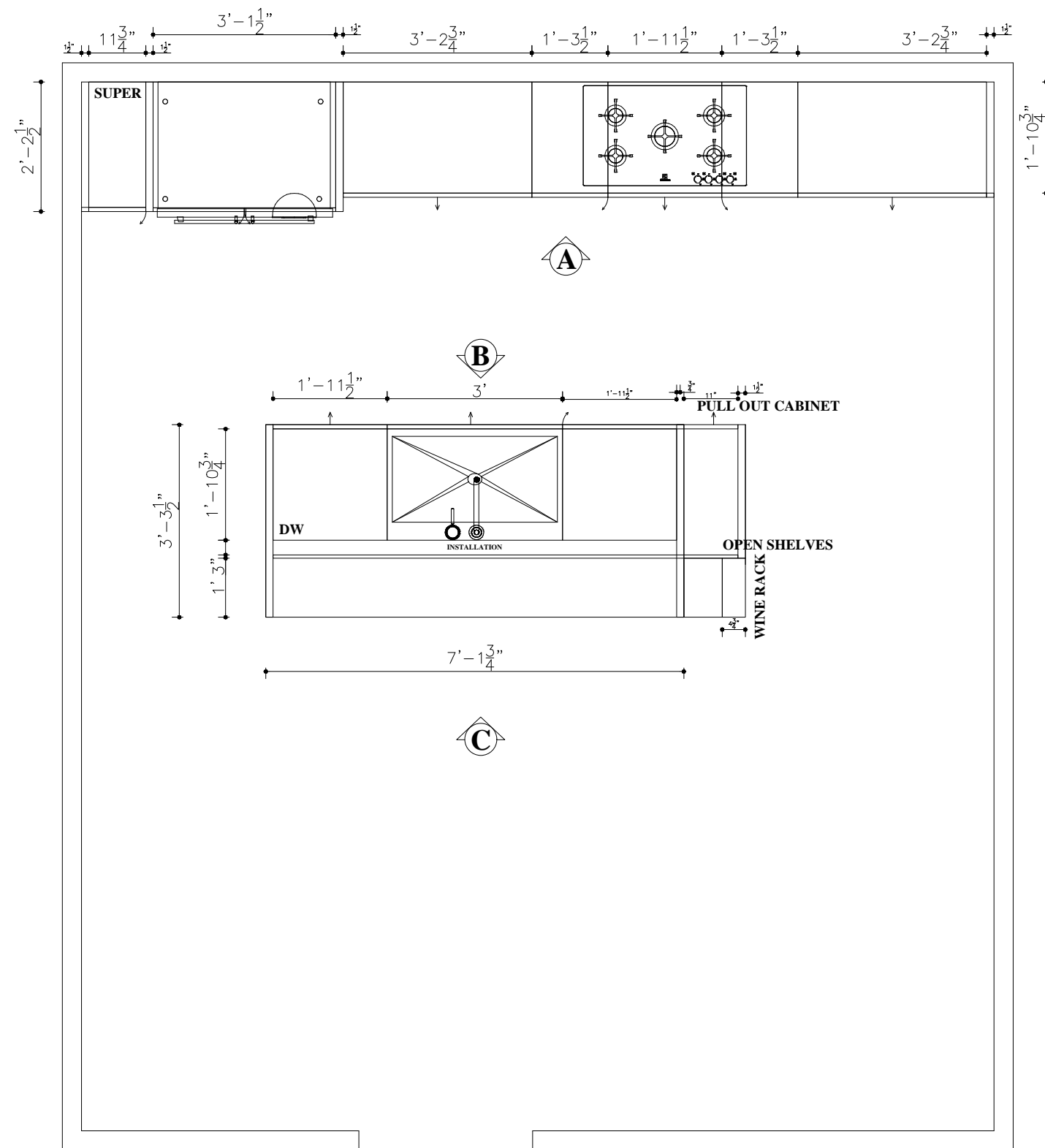

COUNTERTOPS: G034 LACUNA- SIO4

KITCHEN CABINET:  
MDF PAINT BLUE 800  
ONE SHAKER DESIGN

HARDWARES:MODERN SQUARE

SINK:208044 UNDER MOUNT

COOKTOP:  
30"W

SINGLE WALL OVEN:

DISHWASHER:

SIDE BY SIDE REFRIGERATOR:  
36"W

**PLAN VIEW**



**PROJECT TITLE:  
268 RIVER ROAD**

**TITLE:  
KITCHEN DESIGN**

All dimensions are subject to verification and adjustment on jobsite to fit job condition.

**PRODUCED BY:  
N.M**

**SIGN&DATE:**

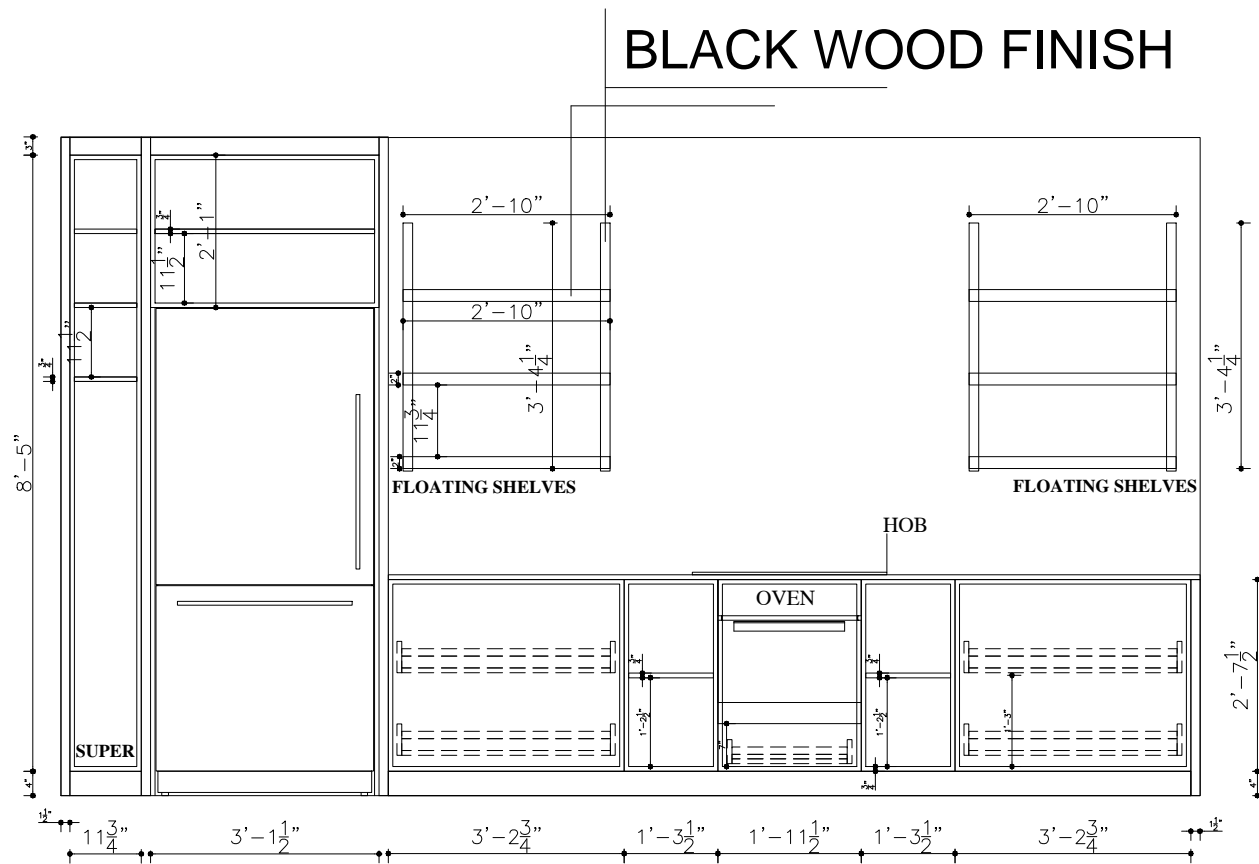

COOKTOP:  
30"W

SINGLE WALL OVEN:

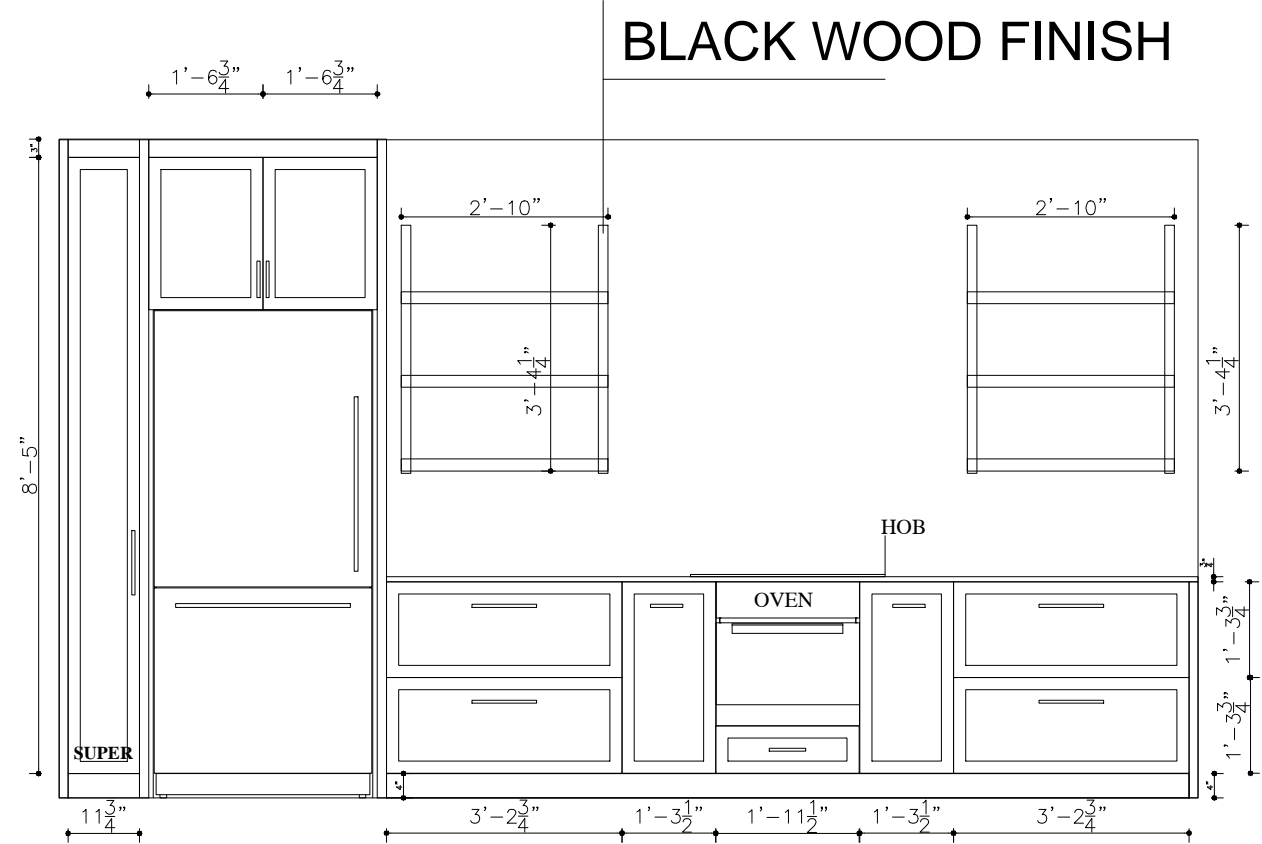

COUNTERTOPS: G034 LACUNA- SIO4

KITCHEN CABINET:  
MDF PAINT BLUE 800  
ONE SHAKER DESIGN

VIEW A



PROJECT TITLE:  
268RIVER ROAD

TITLE:  
KITCHEN DESIGN

All dimensions are subject to verification and adjustment on jobsite to fit job condition.

PRODUCED BY:  
N.M

SIGN&DATE:

**BLACK WOOD FINISH**

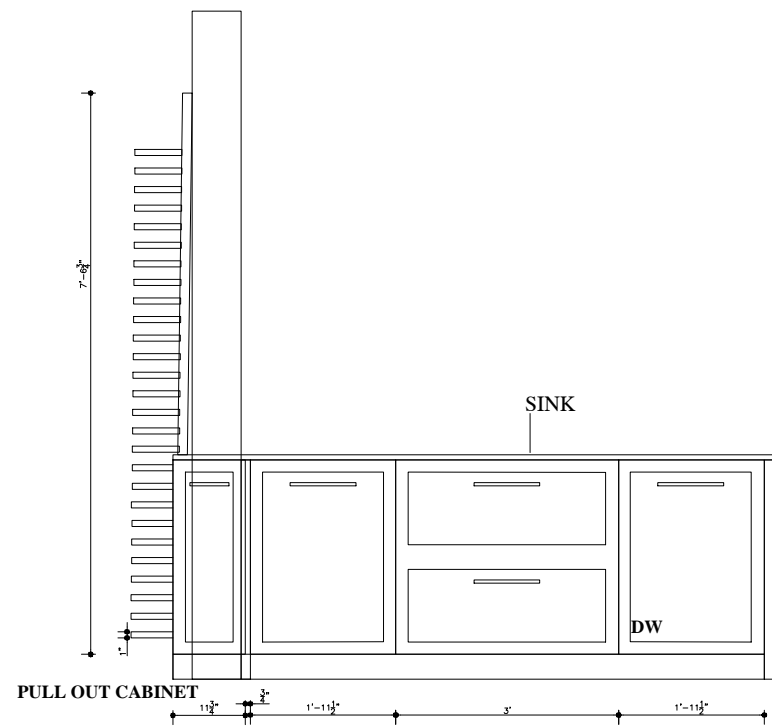
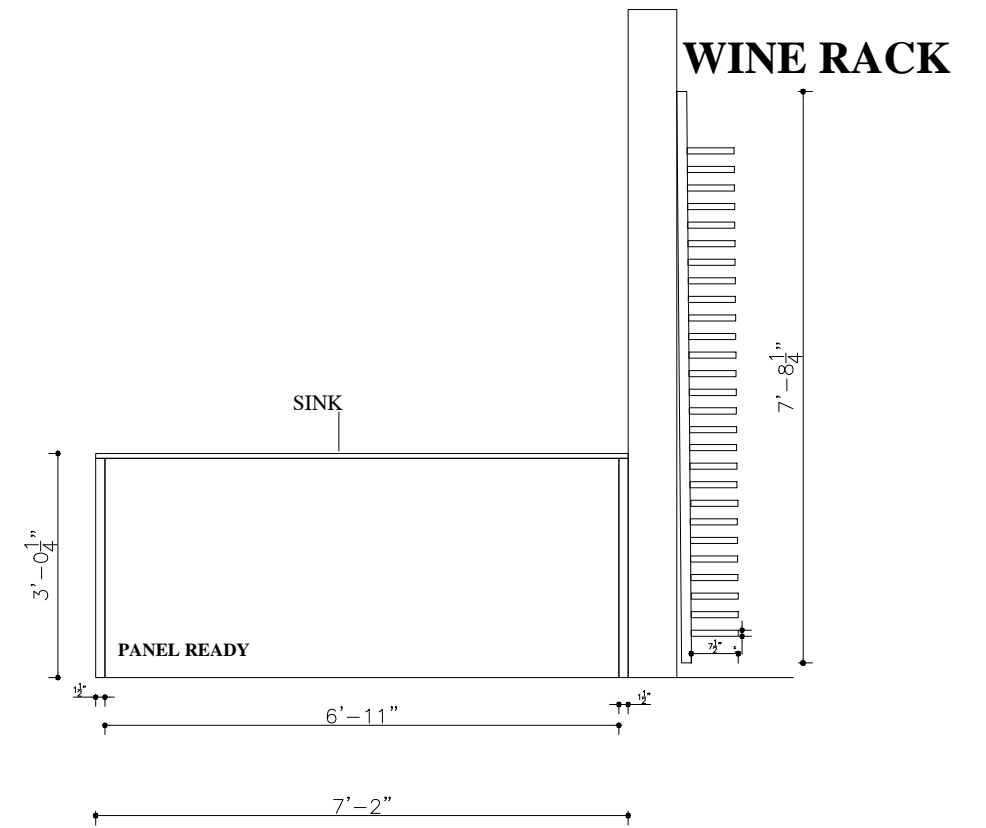
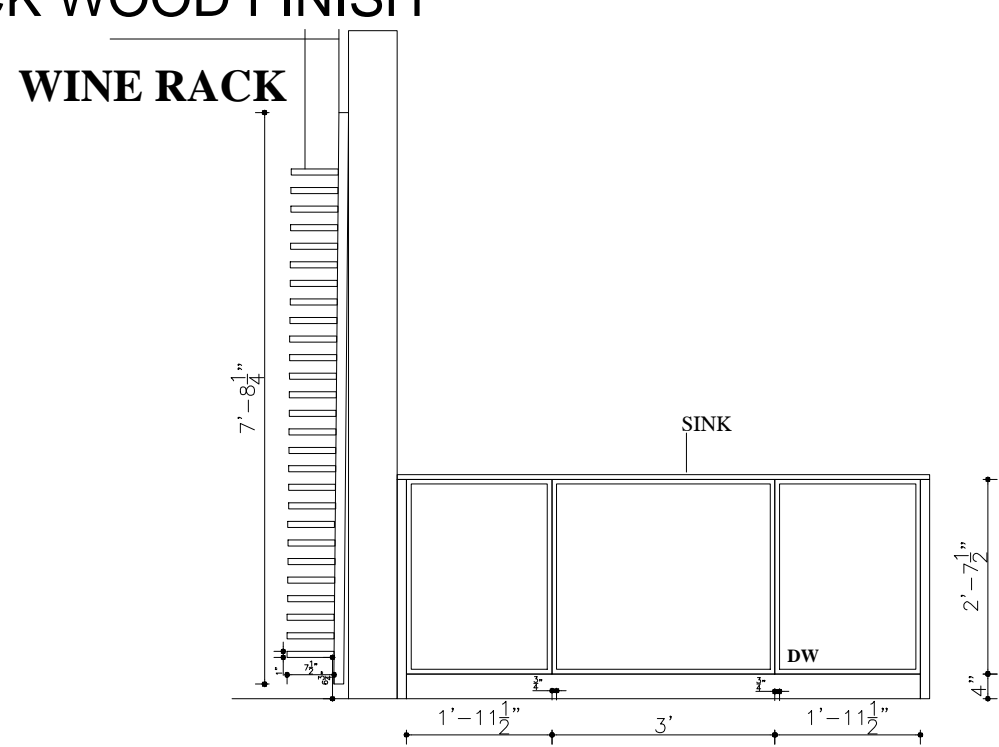

COUNTERTOPS: G034 LACUNA- SIO4

KITCHEN CABINET:  
MDF PAINT BLUE 800  
ONE SHAKER DESIGN

SINK:208044 UNDER MOUNT

**VIEW B . C**



**PROJECT TITLE:  
268 RIVER ROAD**

**TITLE:  
KITCHEN DESIGN**

All dimensions are subject to verification and adjustment on jobsite to fit job condition.

**PRODUCED BY:  
N.M**

**SIGN&DATE:**

FLOOR



MASTER ENSUITE



SHOWER WALLS





SHOWER WALLS



FLOOR

MAIN FLOOR BATHROOM

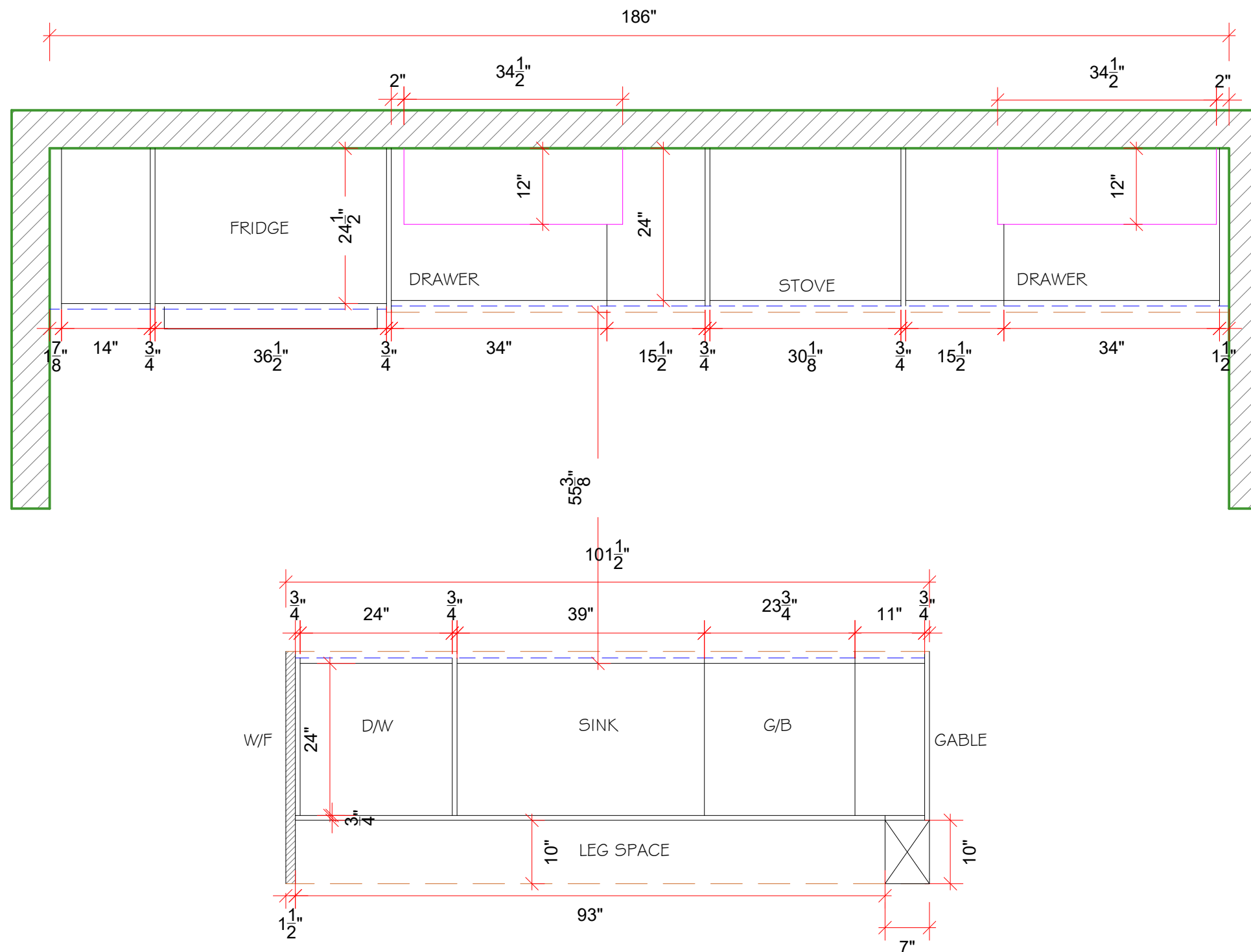

JOB NO.:  
268 RIVER ROAD

CLIENT:

DWG TITLE:  
KITCHEN

DOOR STYLE:  
ANNA I

COLOR :  
MDF PAINT  
BENJAMIN MORE 800

INTERIOR :  
WHITE MELAMINE 5/8"

DRAWER:  
WHITE MELAMINE 5/8"

HANDLE CODE: ----

HANDLE : ----

KNOB: ----

No.	Date	Revision Description
1	JAN25/2024	

DRAWN BY:

APPROVED BY:

PAGE NO: 1

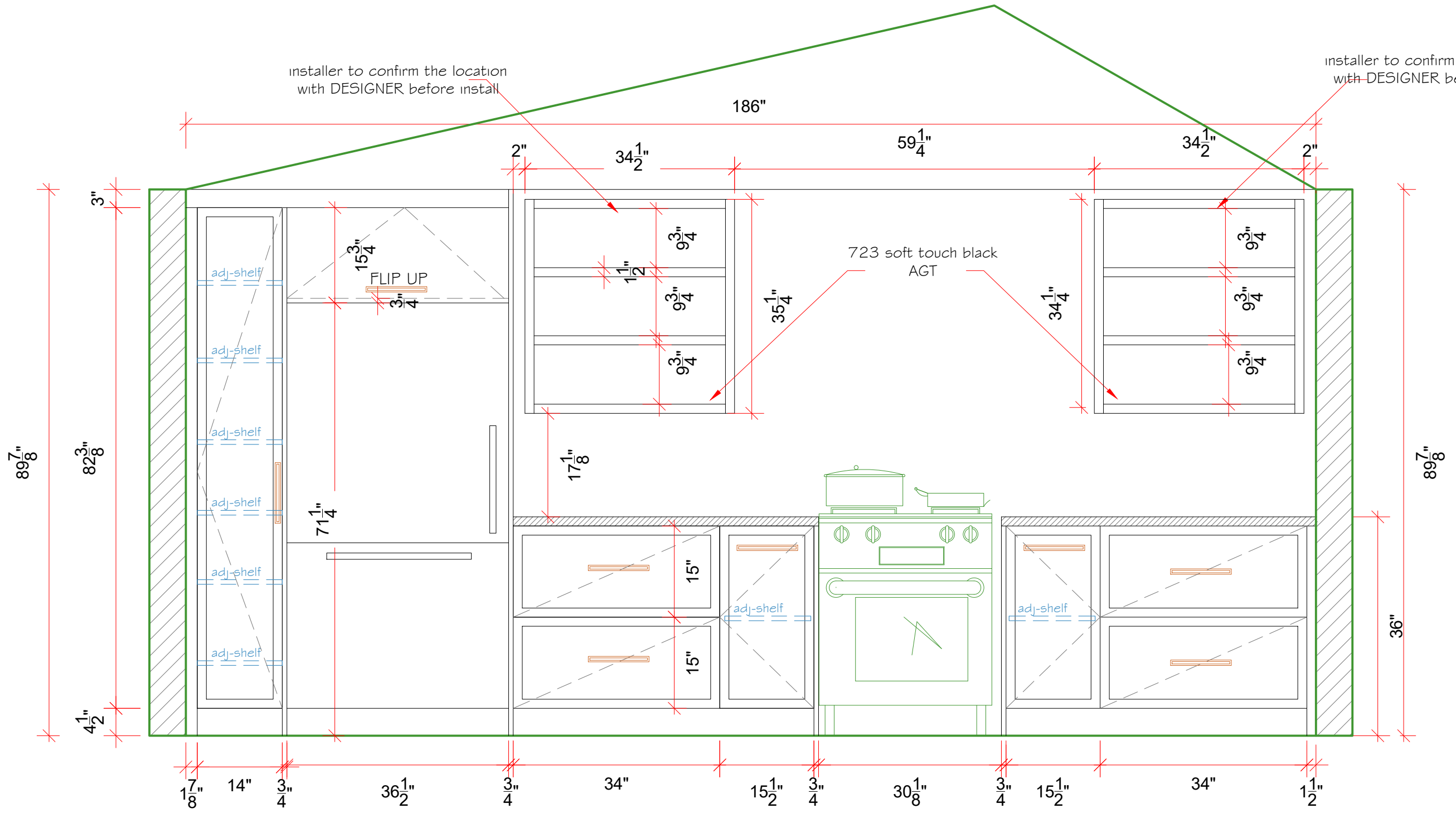

JOB NO.:  
**268 RIVER ROAD**

CLIENT:

DWG TITLE:  
**KITCHEN**

DOOR STYLE:  
**ANNA I**

COLOR :  
**MDF PAINT  
BENJAMIN MORE 800**

INTERIOR :  
**WHITE MELAMINE 5/8"**

DRAWER:  
**WHITE MELAMINE 5/8"**

HANDLE CODE: ----  
HANDLE : ----  
KNOB: ----

No.	Date	Revision Description
1	JAN25/2024	

DRAWN BY:  
APPROVED BY:

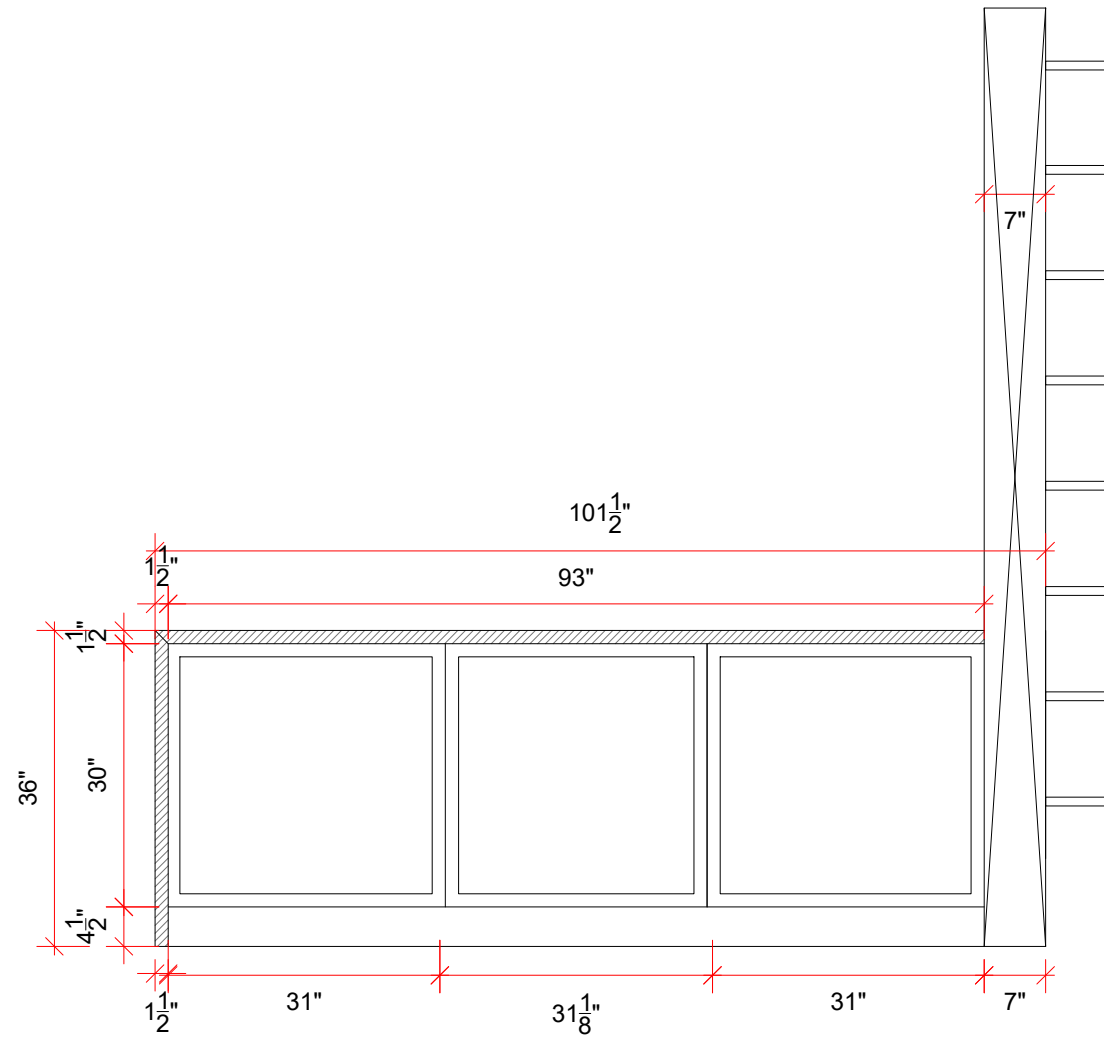
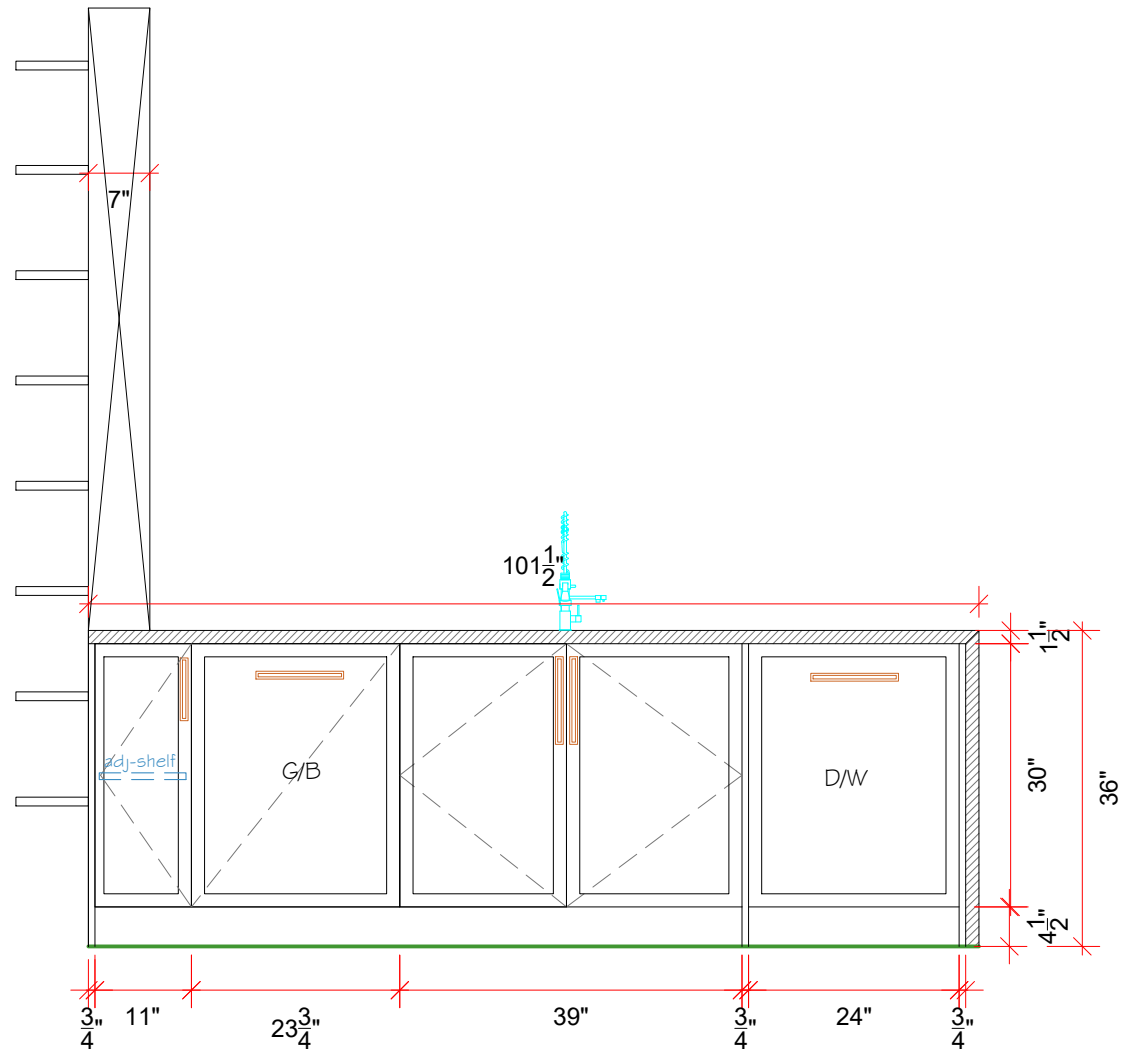

JOB NO.:

**268 RIVER ROAD**

CLIENT:

DWG TITLE:

**ISLAND**

DOOR STYLE:

**ANNA I**

COLOR :

**MDF PAINT  
BENJAMIN MORE 800**

INTERIOR :

**WHITE MELAMINE 5/8"**

DRAWER:

**WHITE MELAMINE 5/8"**

HANDLE CODE: ----

HANDLE : ----

KNOB: ----

No.	Date	Revision Description
1	JAN25/2024	

DRAWN BY:

APPROVED BY:

PAGE NO: **3**